







36 503 985



- Abdeckplatte 120 x 120 mm
- Skalengriff mit Sicherheitssperre bei 38°C
- Thermostat-Kartusche

Passt zu: IMO, MEM, CL.1, CYO

	Chrom gebürstet	36 503 985-93
	Chrom	36 503 985-00
	Platin gebürstet	36 503 985-06
	Platin	36 503 985-08
	Dark Chrome	36 503 985-19
	Messing gebürstet (23kt Gold)	36 503 985-28
	Schwarz matt	36 503 985-33
	Champagne gebürstet (22kt Gold)	36 503 985-46
	Champagne (22kt Gold)	36 503 985-47
	Dark Platin gebürstet	36 503 985-99

Benötigtes Zubehör



- xTOOL UP-Thermostatmodul ohne Mengenregulierung -** 35 503 970 90
- Max. Einbautiefe 160 mm
 - Min. Einbautiefe 95 mm

Benötigtes Zubehör



- xGRID Montageschiene 555 mm -** 12 360 970 90

Empfohlenes Zubehör



- xGRID Befestigungssatz für die Integration in den Trockenbau -** 12 340 970 90

36 503 985

mm [inches]



Durchflussdiagramm



Zertifikate

WRAS_2011026.

DVGW_DW-
6512DN0706.

LGA_29930.

LGA_29932.

36 503 985

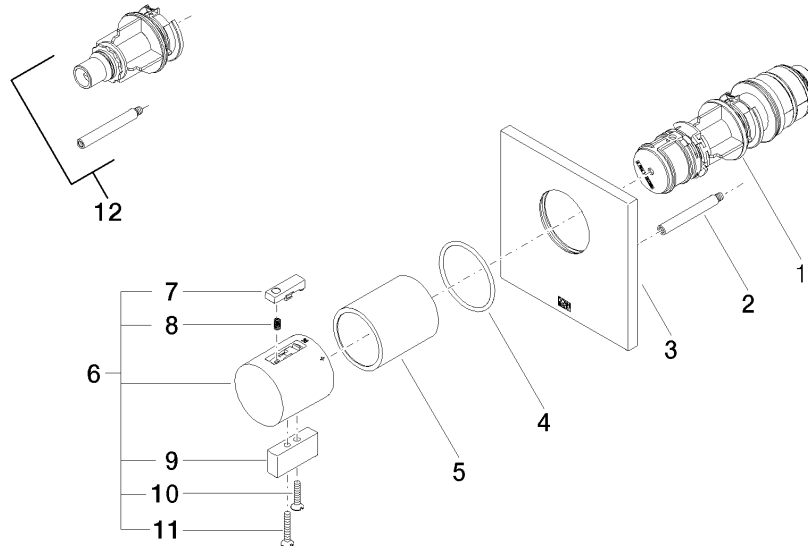

Ersatzteilstückliste

Nr.	Artikelnummer	Benennung	Verbaumenge	Lieferzeit
1	90 15 02 065 00 90	Kartusche	1	2
2	90 31 09 095 00 90	Stange	1	2
3	09 11 02 196-93	Abdeckung	1	60
4	90 14 10 049 00 90	Dichtung	1	2
5	90 21 02 112 00-93	Huelse	1	-
Ersatzteil nicht mehr bestellbar, bitte bestellen Sie den Nachfolgeartikel				
6	04 17 33 006 00-93	Griff	1	60
7	90 21 33 011 00-13	Griff	1	2
8	90 16 02 027 00 90	Feder	1	2
9	09 20 33 006-93	Griff	1	20
10	09 30 30 159-93	Schraube	1	20
11	09 30 30 160-93	Schraube	1	20
12	12 178 970 90	Verlängerung 46 mm -	1	2